

*Peter-Paul-Kirche  
(Senftenberg)*

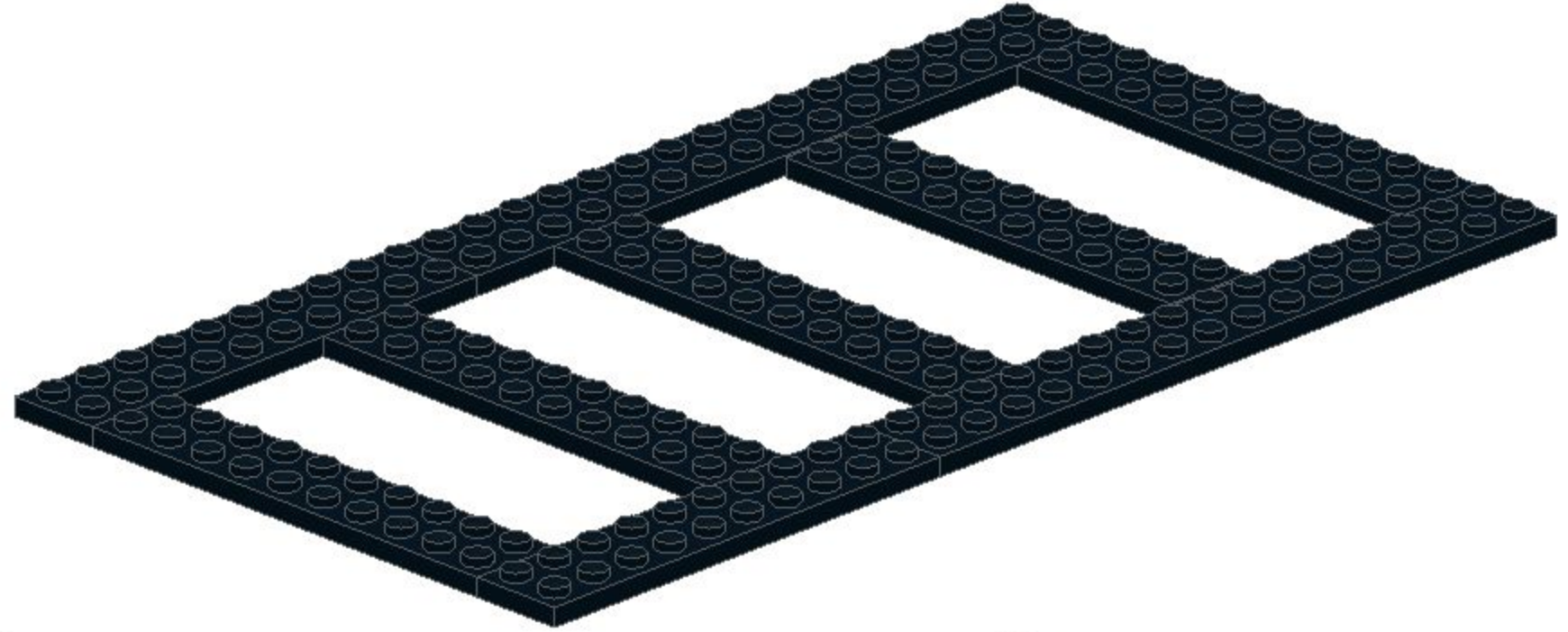

1

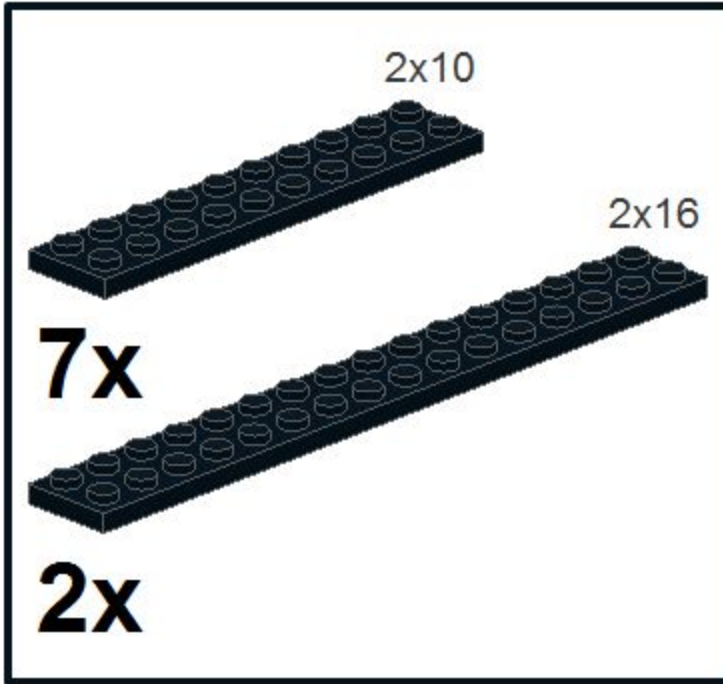



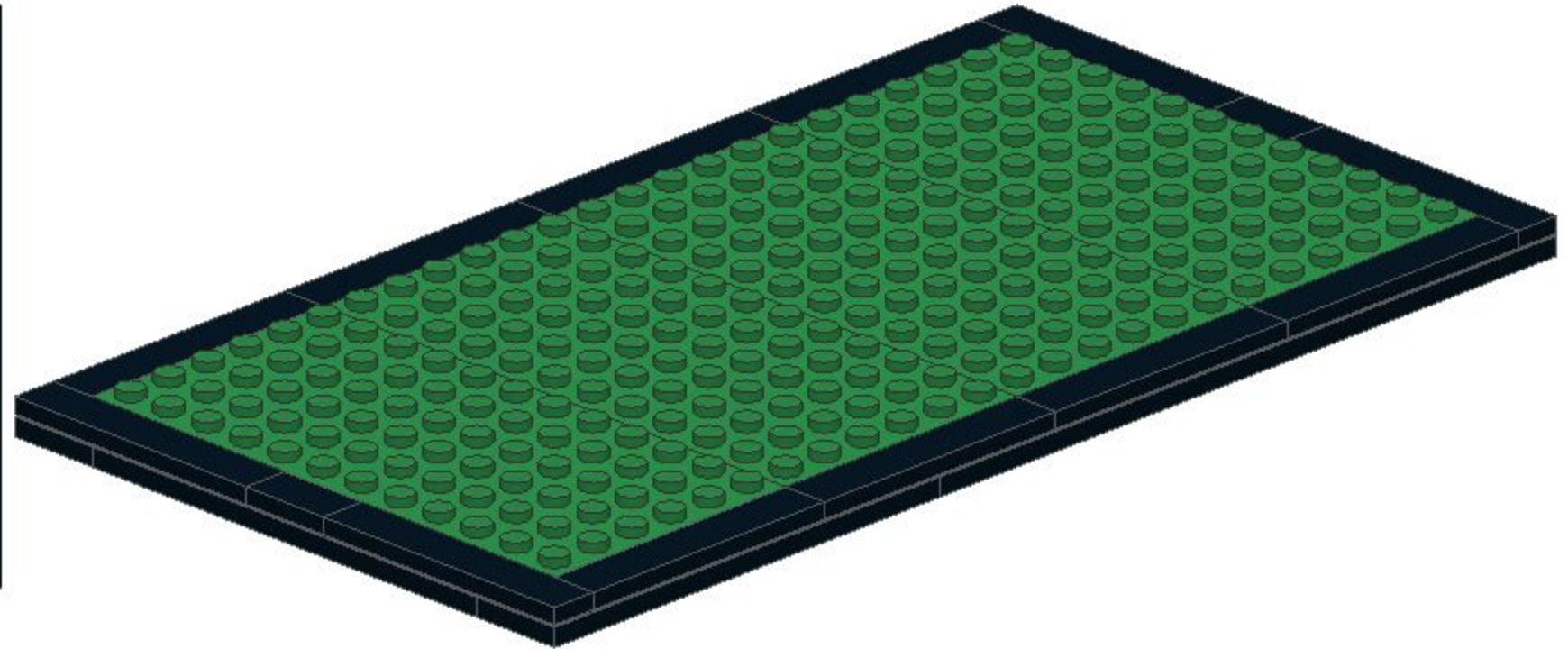
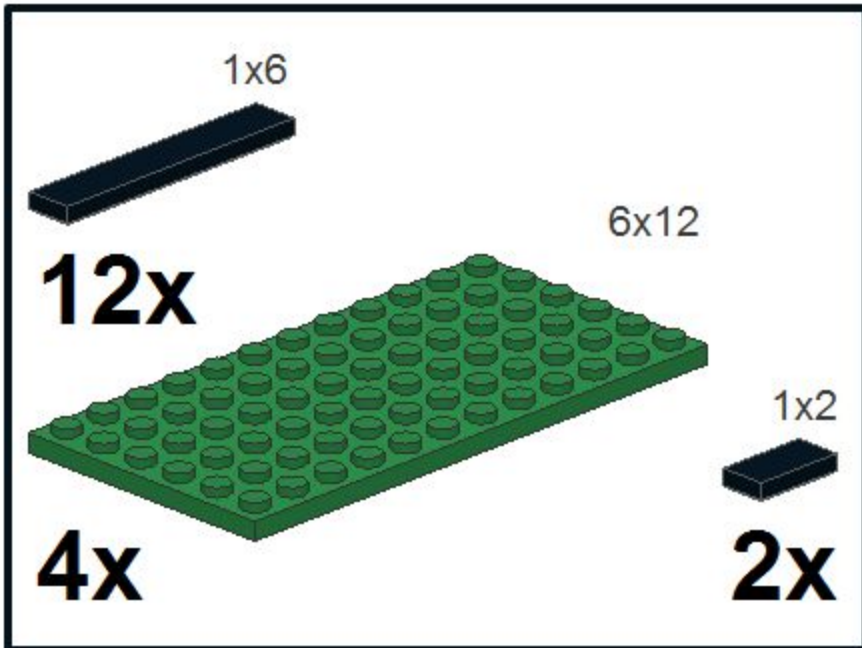

2

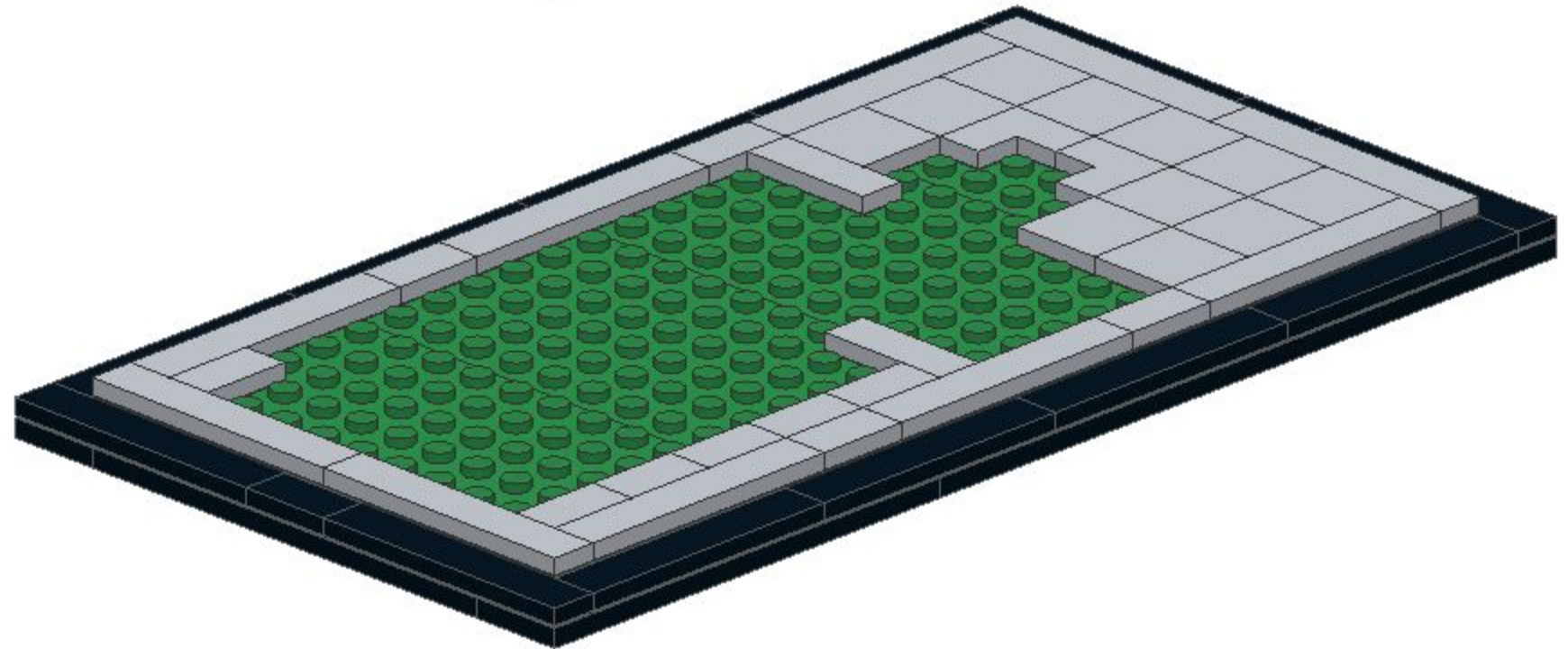
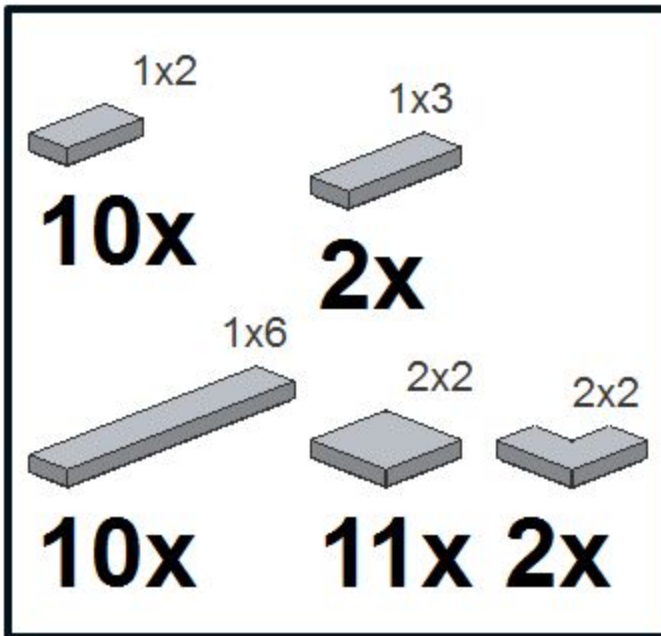

3

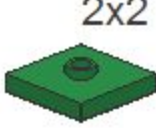
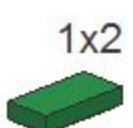

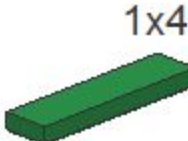



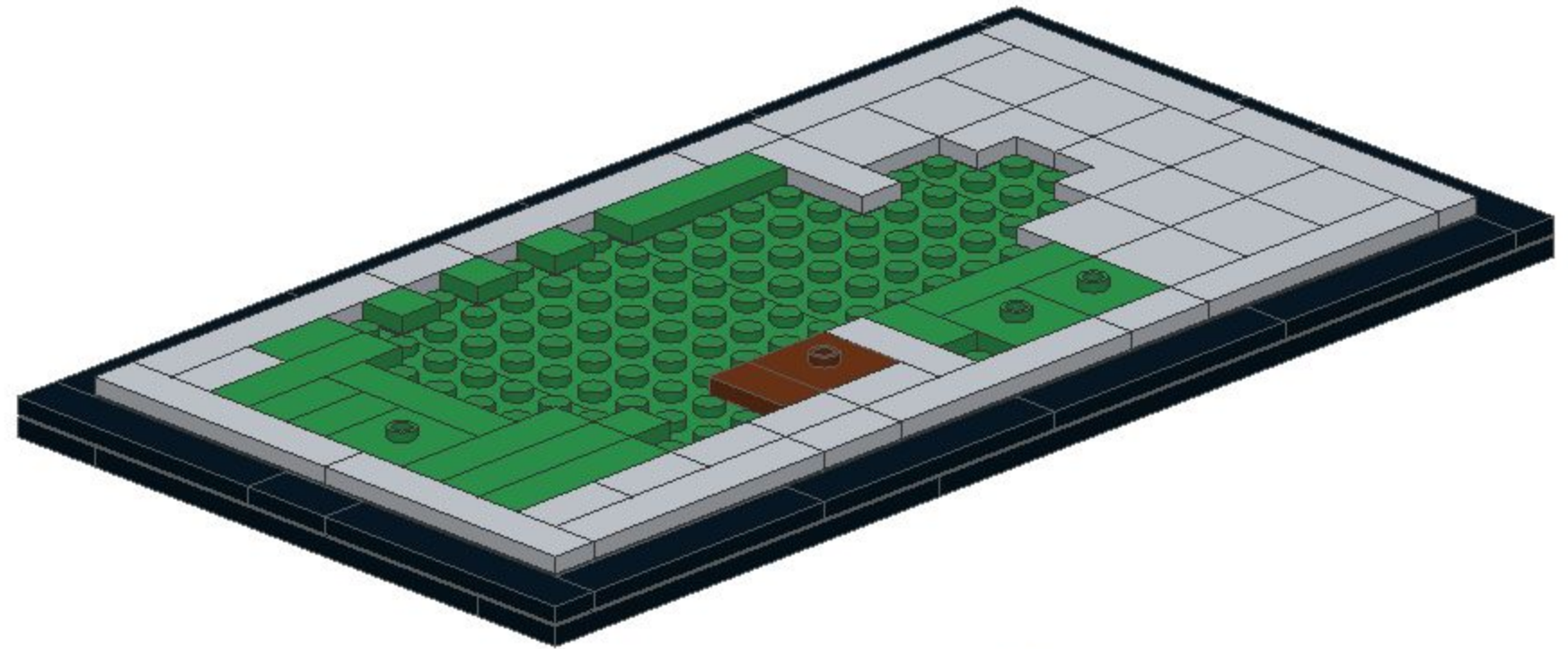

# 4

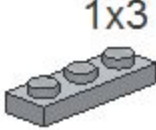
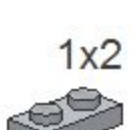
 2x2	 1x2	 1x1
<b>3x</b>	<b>4x</b>	<b>4x</b>
 1x4	 2x2	 1x2
<b>7x</b>	<b>1x</b>	<b>1x</b>

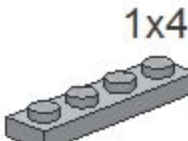

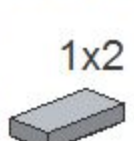



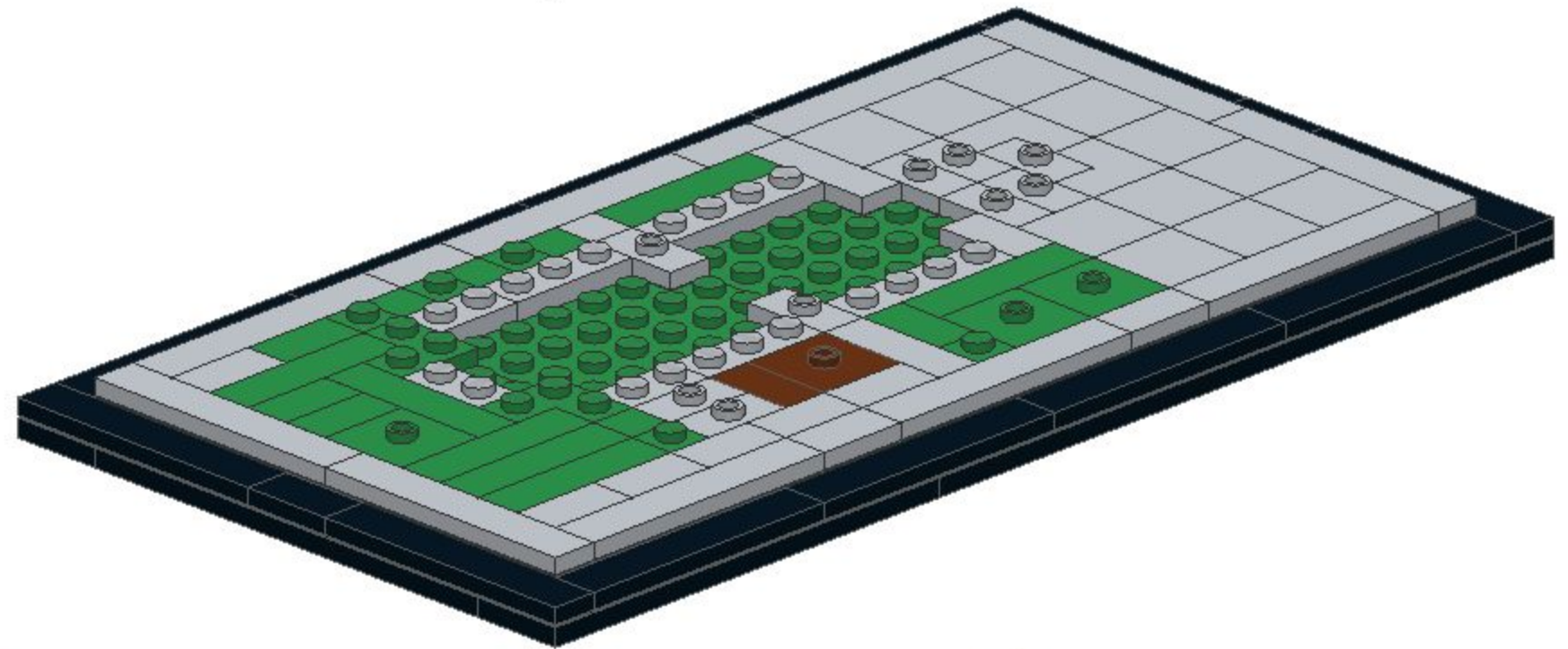

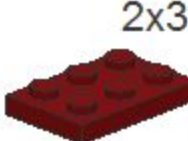

# 5

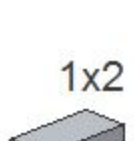
 1x3	 1x2	 1x2	 1x1
<b>2x</b>	<b>3x</b>	<b>9x</b>	<b>1x</b>
 1x4	 2x2	 1x2	 1x1
<b>2x</b>	<b>2x</b>	<b>1x</b>	<b>5x</b>

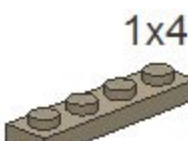
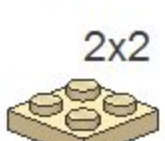

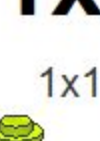

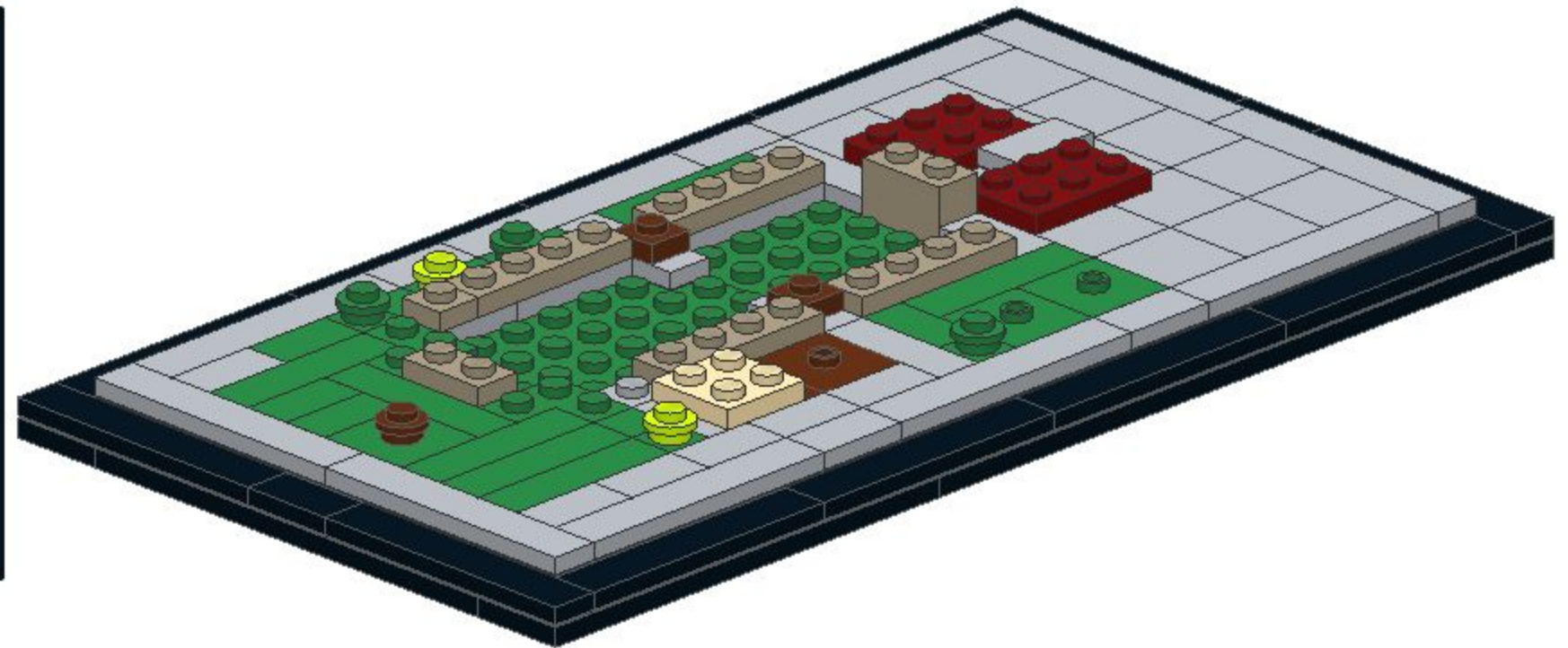

# 6

 2x3	 1x2	 1x2	 1x1	 1x1	
<b>2x</b>	<b>1x</b>	<b>1x</b>	<b>2x</b>	<b>1x</b>	
 1x4	 2x2	 1x2	 1x1	 1x1	 1x1
<b>4x</b>	<b>1x</b>	<b>1x</b>	<b>1x</b>	<b>2x</b>	<b>3x</b>

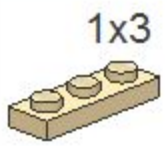
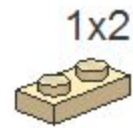

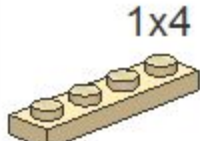
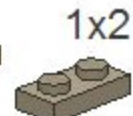

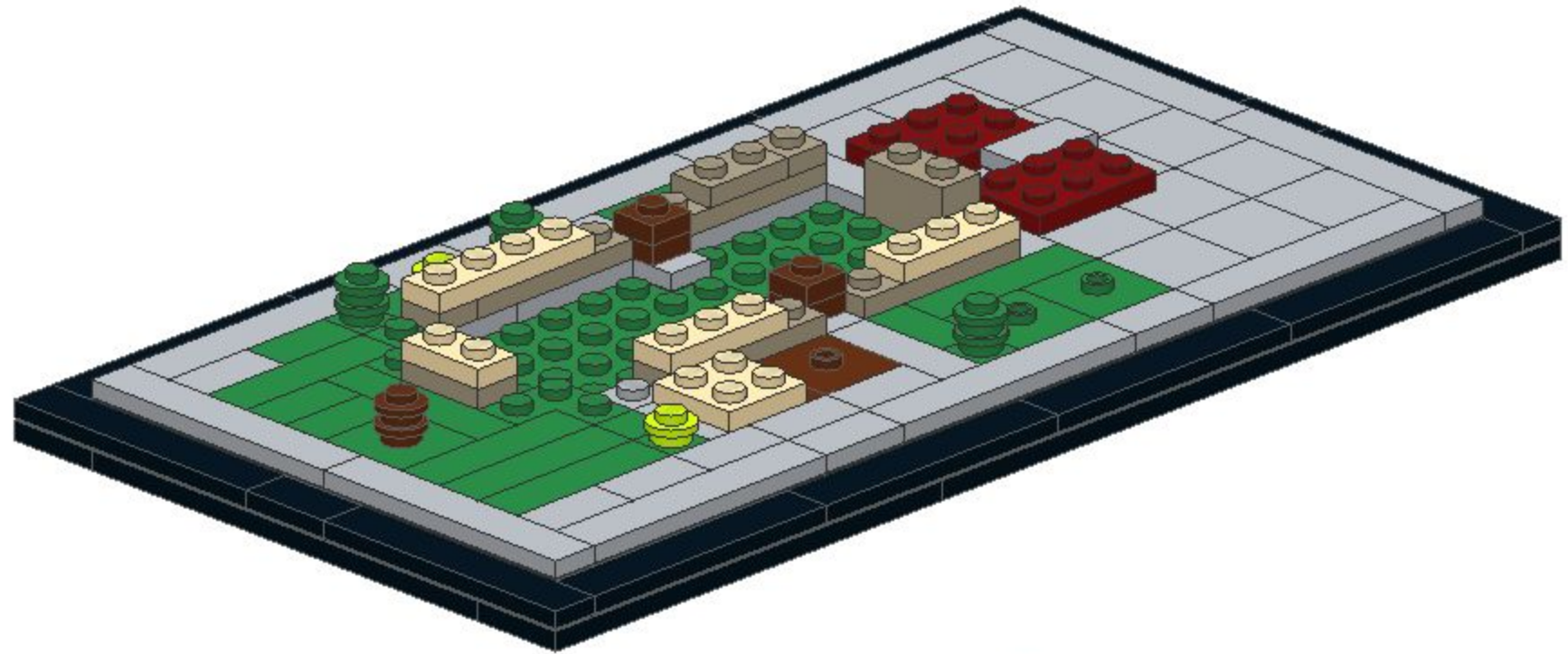

7

			
<b>2x</b>	<b>1x</b>	<b>2x</b>	<b>3x</b>
			
<b>1x</b>	<b>1x</b>	<b>1x</b>	<b>1x</b>



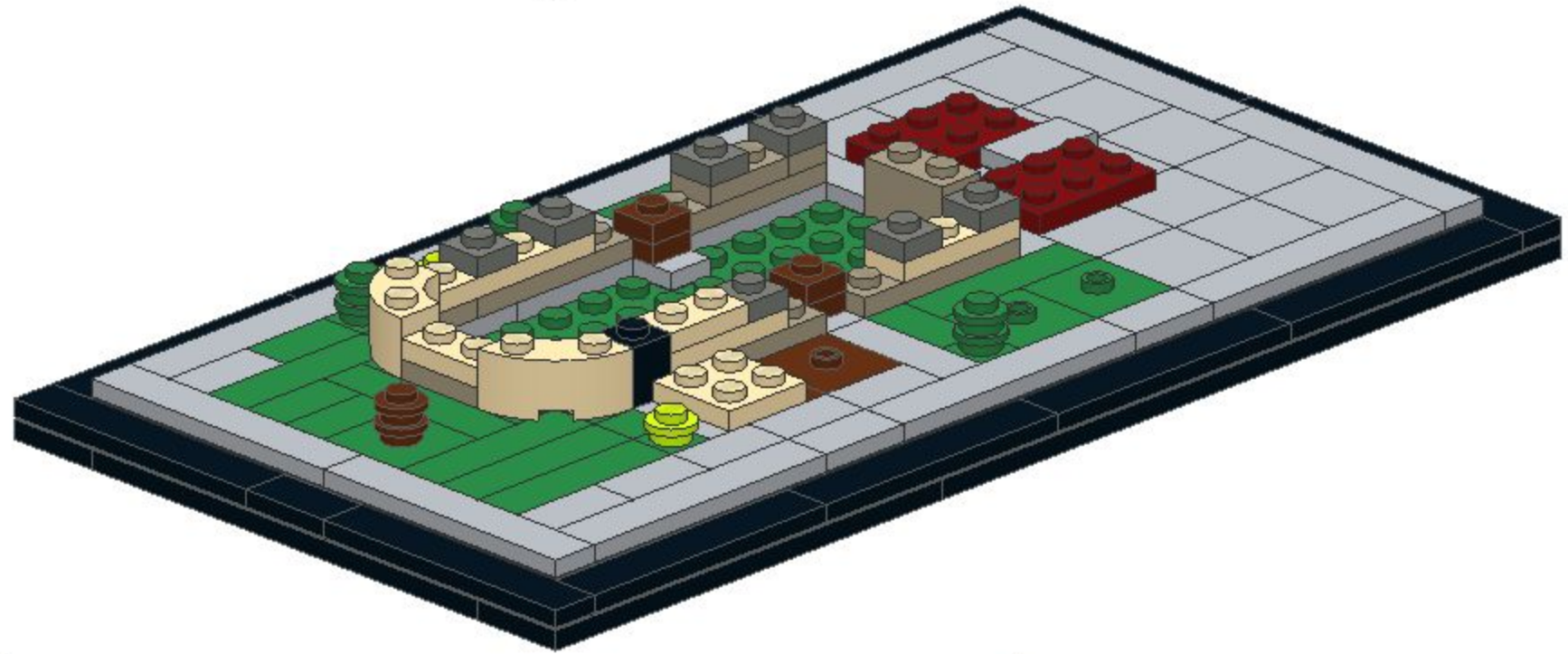

8

	
<b>1x</b>	<b>7x</b>
	
<b>2x</b>	<b>1x</b>



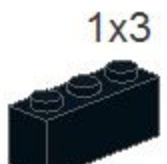
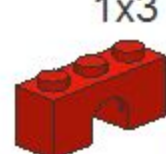

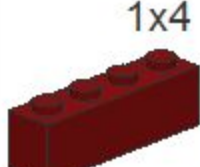
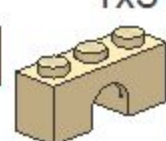
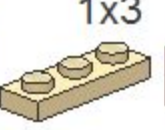
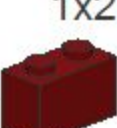

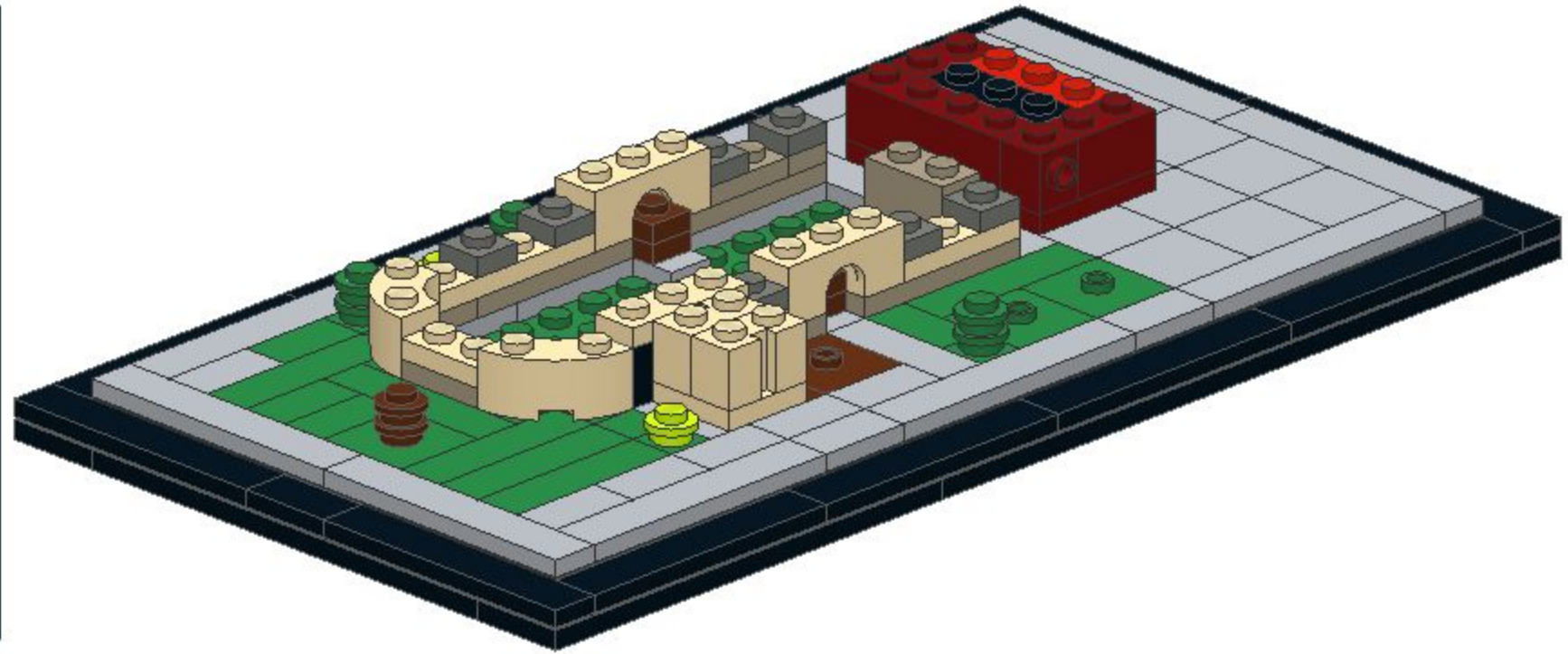

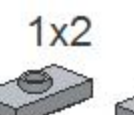

9

			
<b>1x</b>	<b>1x</b>	<b>2x</b>	<b>1x</b>
			
<b>1x</b>	<b>2x</b>	<b>1x</b>	<b>2x</b>

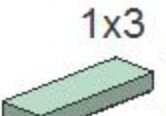

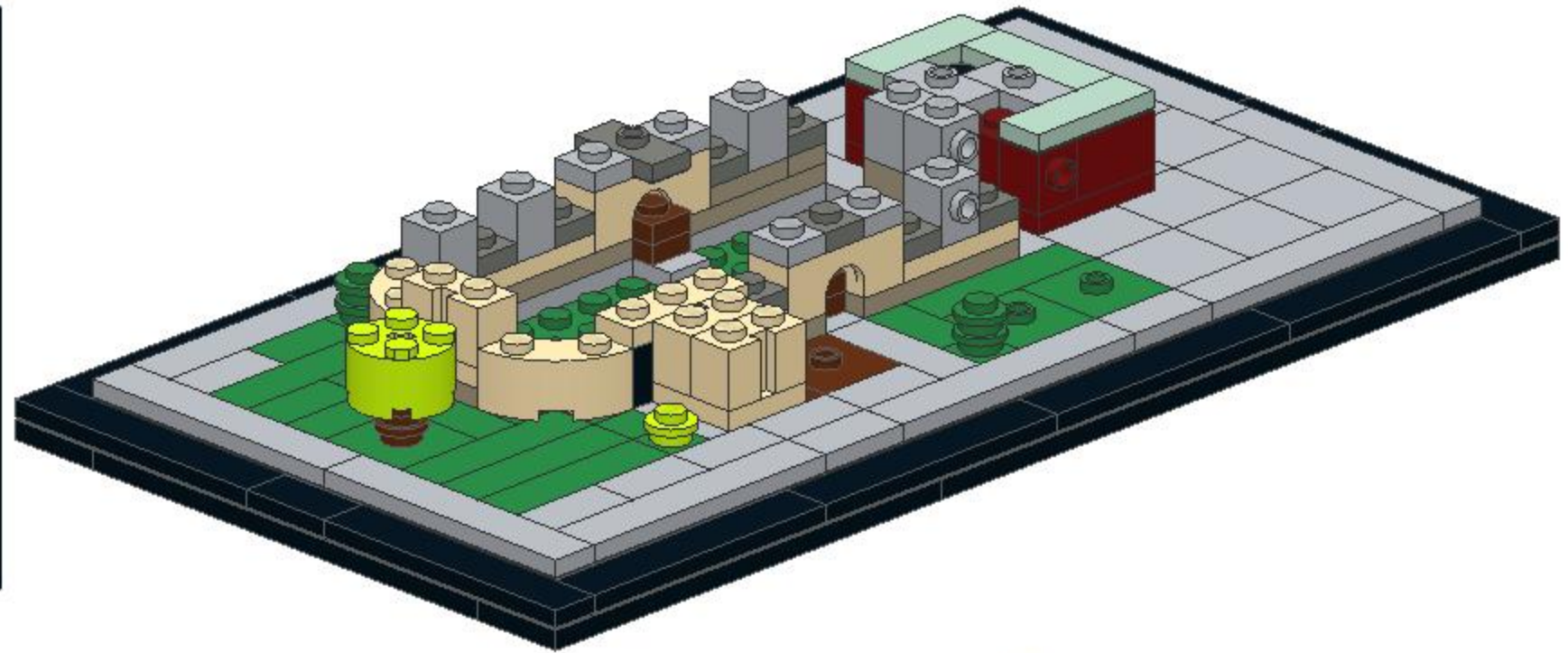

# 10

 2x2	 1x1	 1x2	 1x1
<b>1x</b>	<b>6x</b>	<b>2x</b>	<b>4x</b>
 1x3	 1x2	 1x2	 1x1
<b>3x</b>	<b>1x</b>	<b>1x</b>	<b>1x</b>



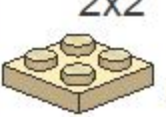
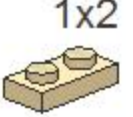
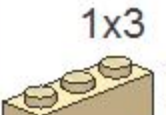

# 11

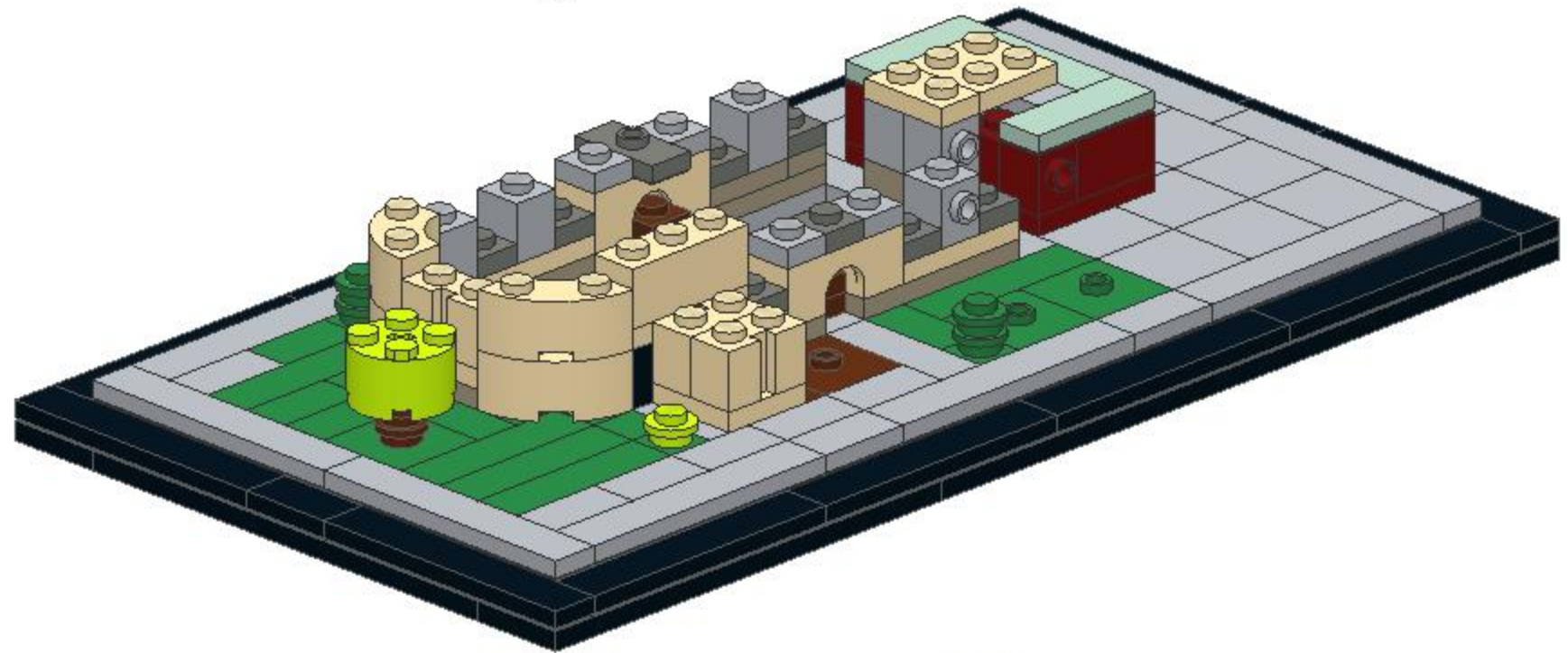
 2x2	 1x2
<b>1x</b>	<b>1x</b>
 1x3	 2x2
<b>1x</b>	<b>2x</b>



# 12

 1x1	
<b>8x</b>	
 2x2	 1x2
<b>1x</b>	<b>1x</b>

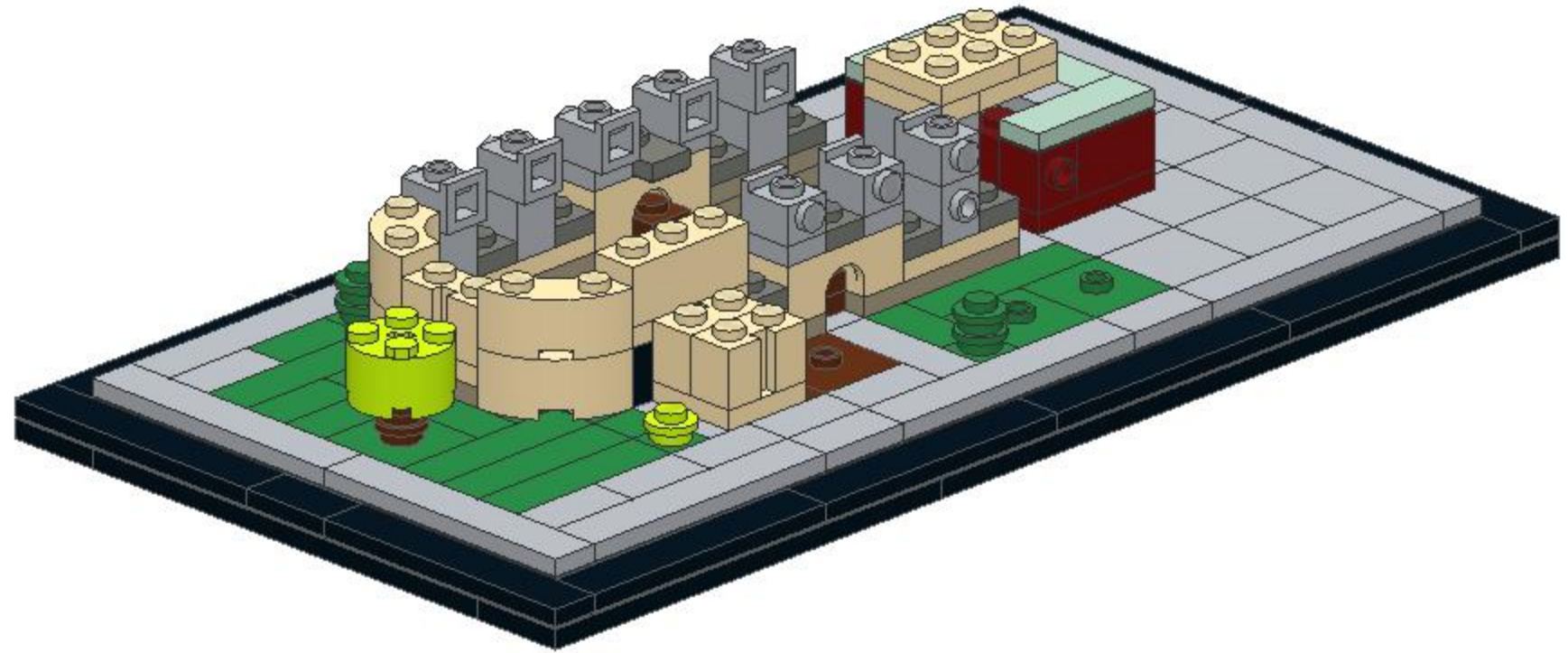

# 13

2x	1x	
1x	1x	8x

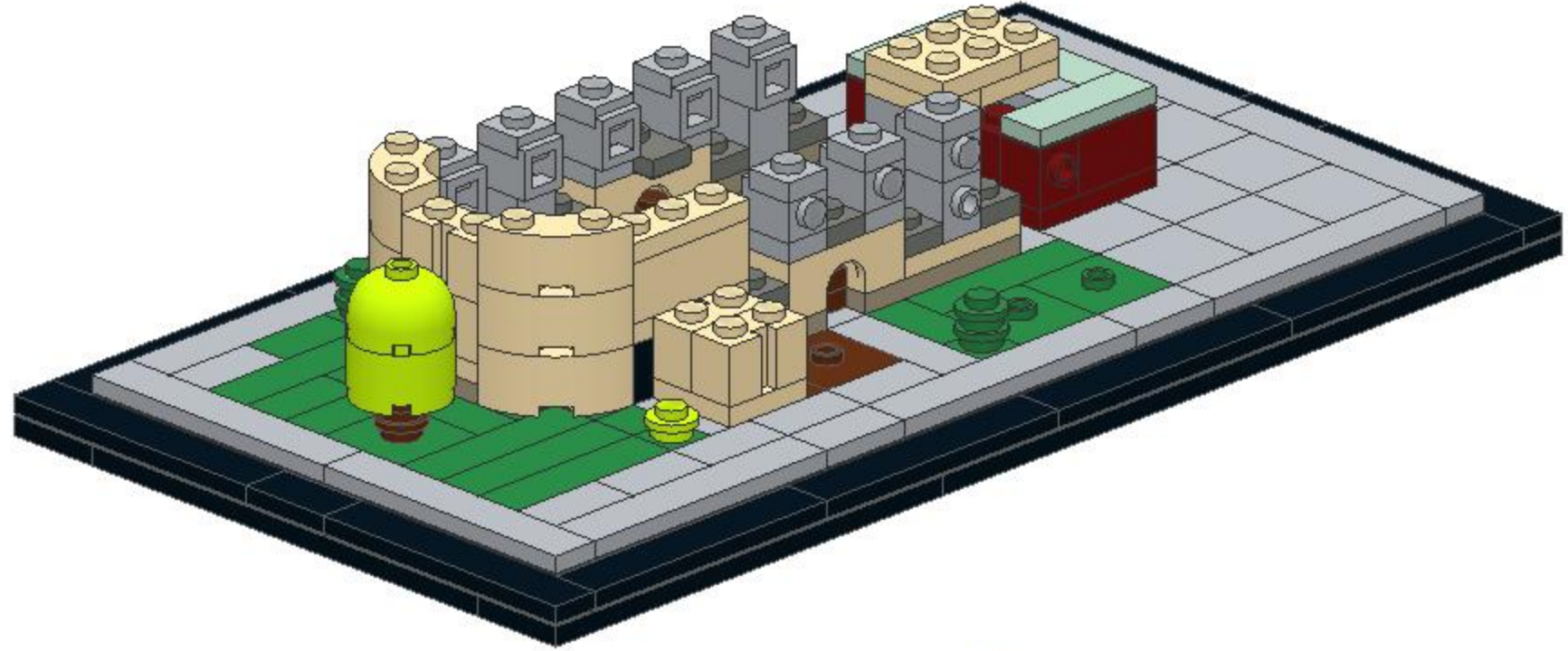

# 14

	1x1
41x	

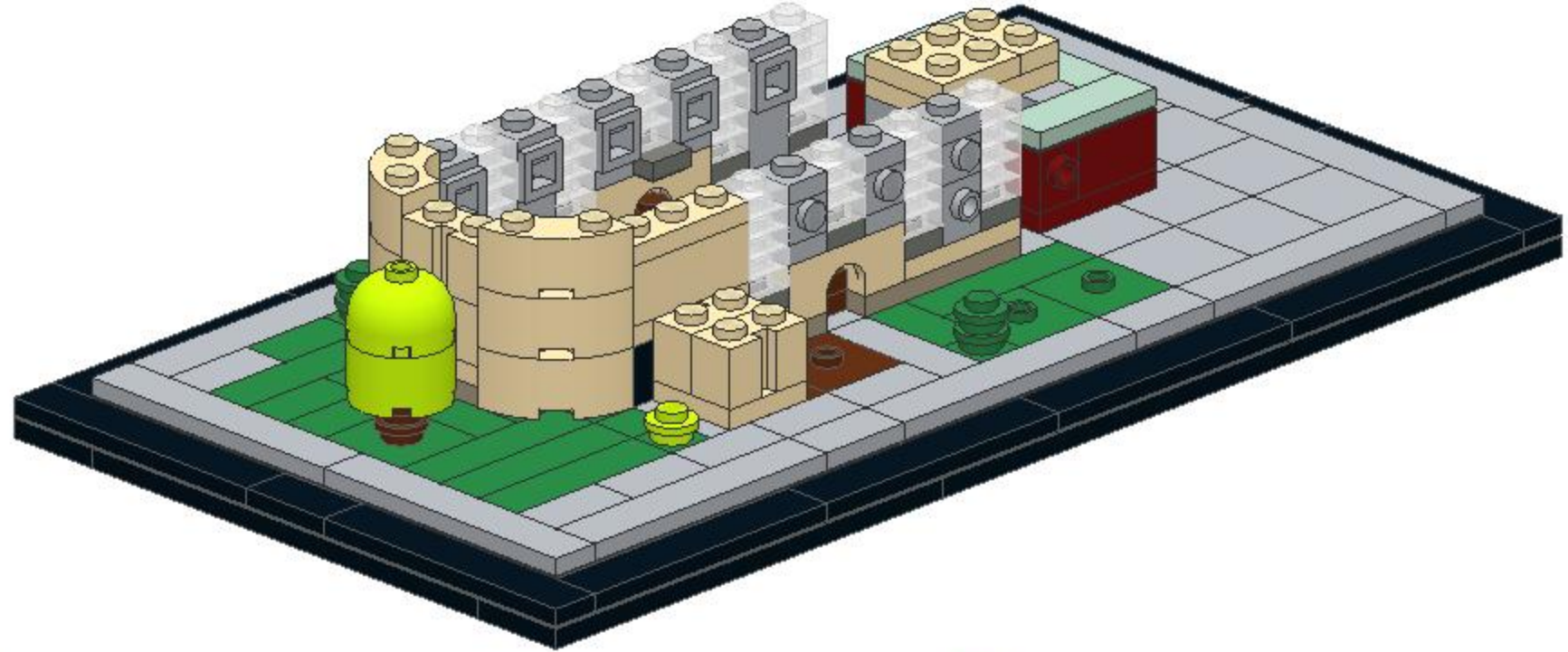

# 15

1x	2x	1x
2x	1x	2x

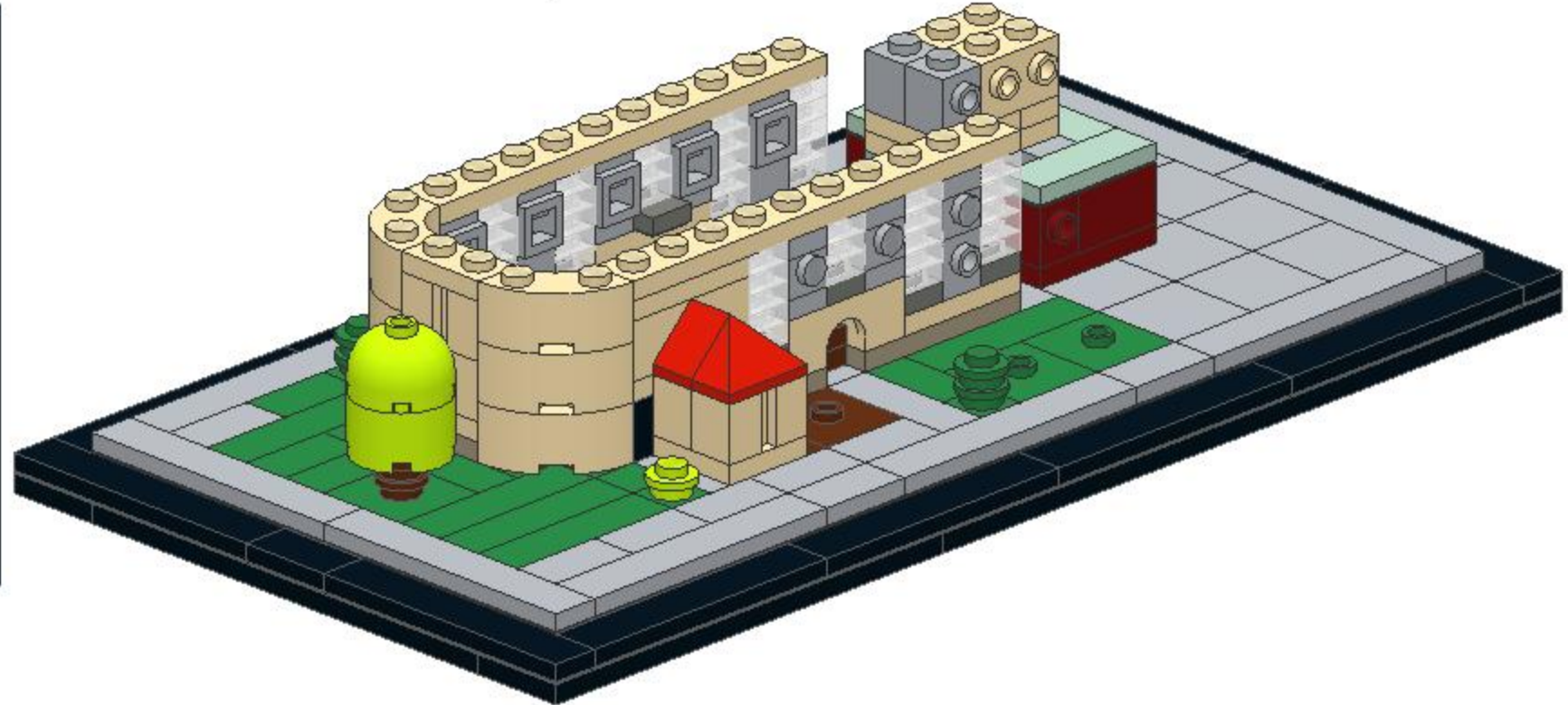

# 16

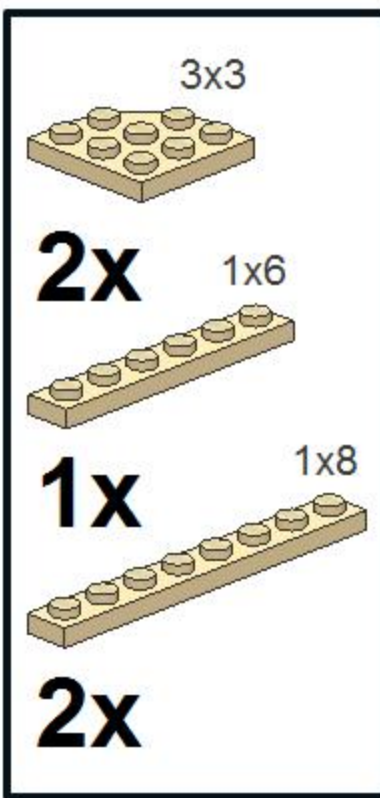

# 17

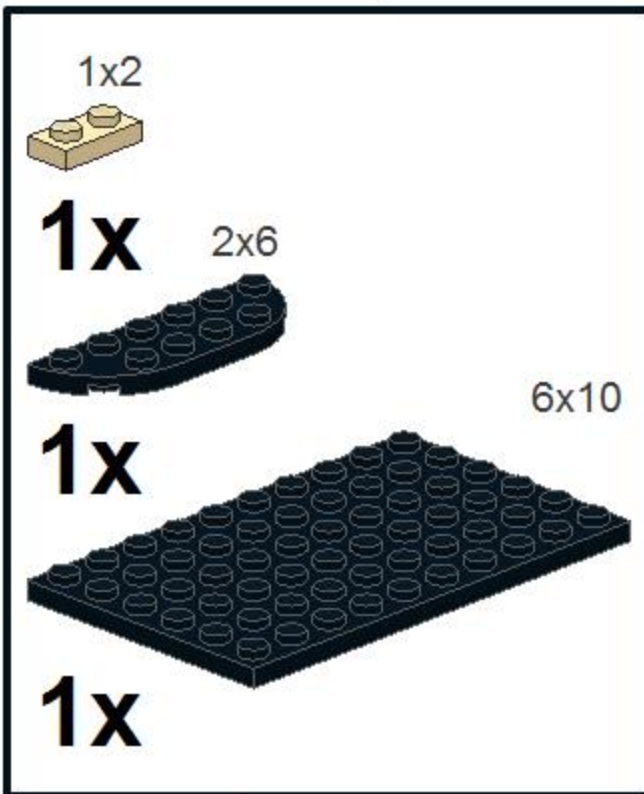

# 18

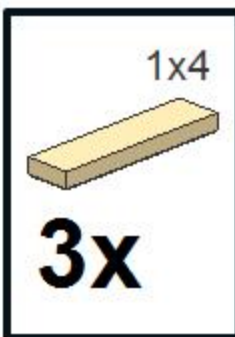



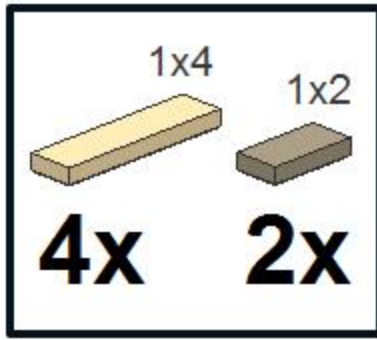



19

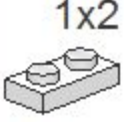

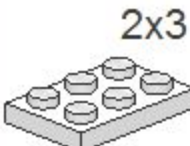



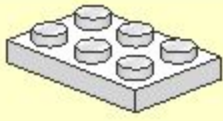
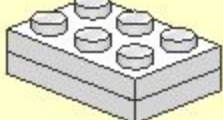

# 20

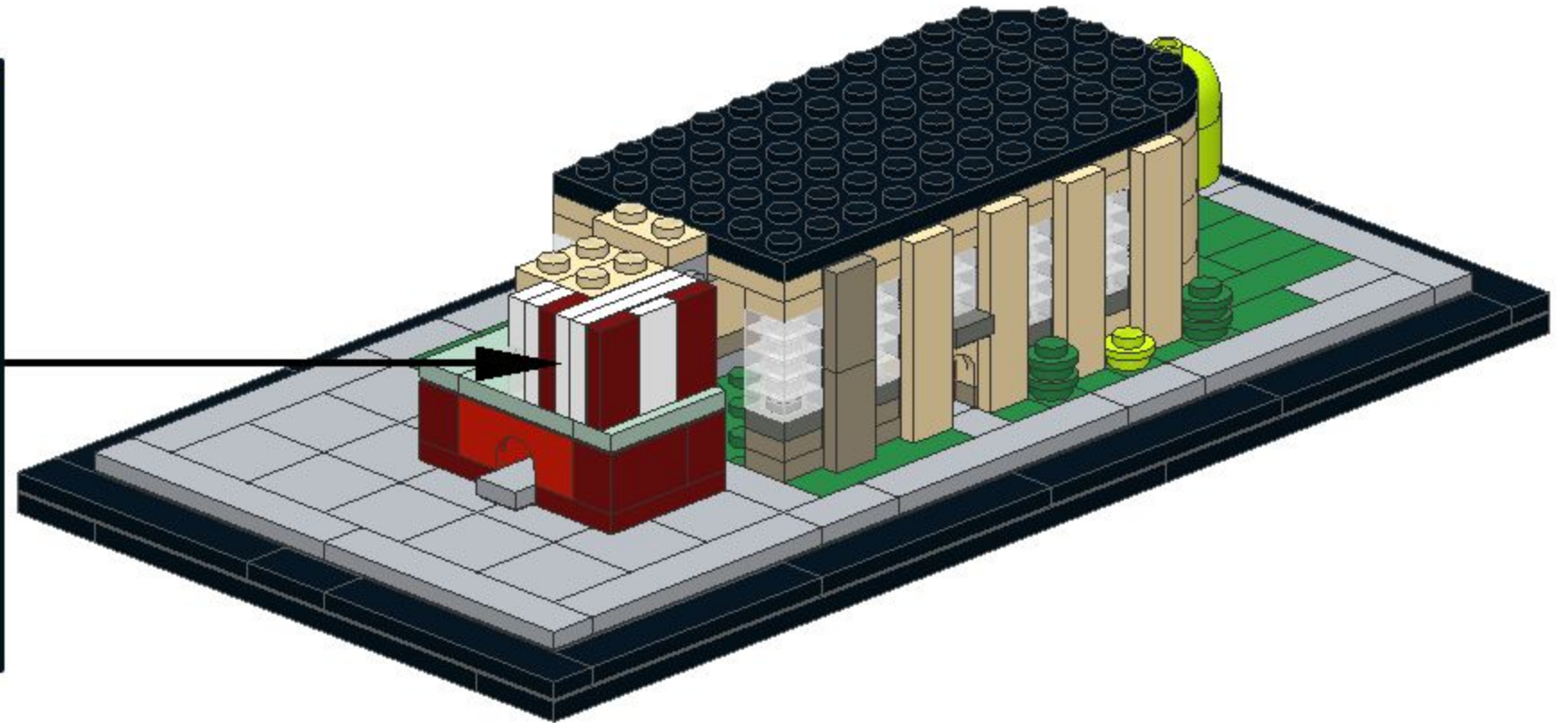

		1x2
	<b>2x</b>	
		1x2
<b>1x</b>	<b>1x</b>	
		
<b>2x</b>	<b>1x</b>	<b>1x</b>

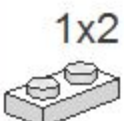
- 1 
- 2 
- 3 
- 4 

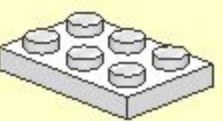
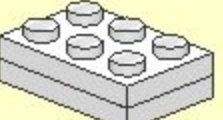
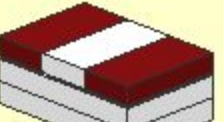

# 21

		1x2
<b>1x</b>	<b>1x</b>	
		
<b>2x</b>	<b>1x</b>	<b>2x</b>

- 1 
- 2 
- 3 
- 4 



# 22

1x1  
 1x1

2x  
 2x3

1x  
 1x1

2x  
1x





# 23

1x1  
 1x1

1x  
 1x3

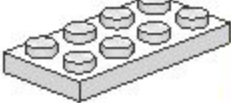
1x  
 1x1

2x  
 2x4

1x  
 1x1

1x  
1x



# 24

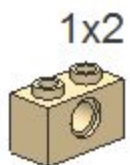

1x2

1x

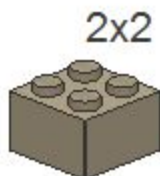

2x2

1x

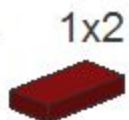

1x2

4x



# 25

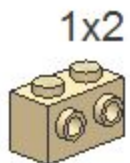

1x2

2x

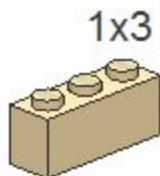

1x3

1x



# 26



2x



1x1

1x







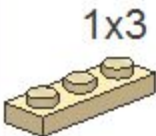

1x1

1x

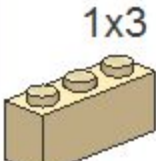
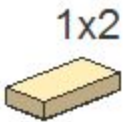
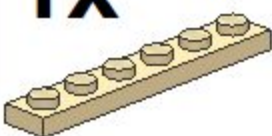





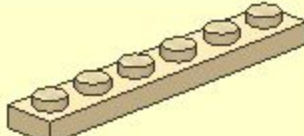
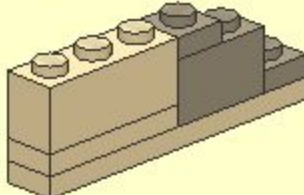
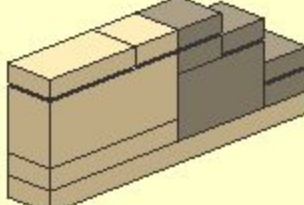

# 27

	
<b>1x</b>	<b>2x</b>
	
<b>1x</b>	<b>1x</b>
	
<b>1x</b>	<b>1x</b>
	
	
	<b>3x</b>

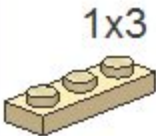
- 1** 
- 2** 
- 3** 

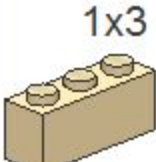
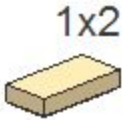
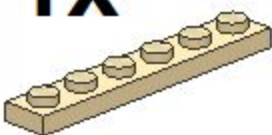





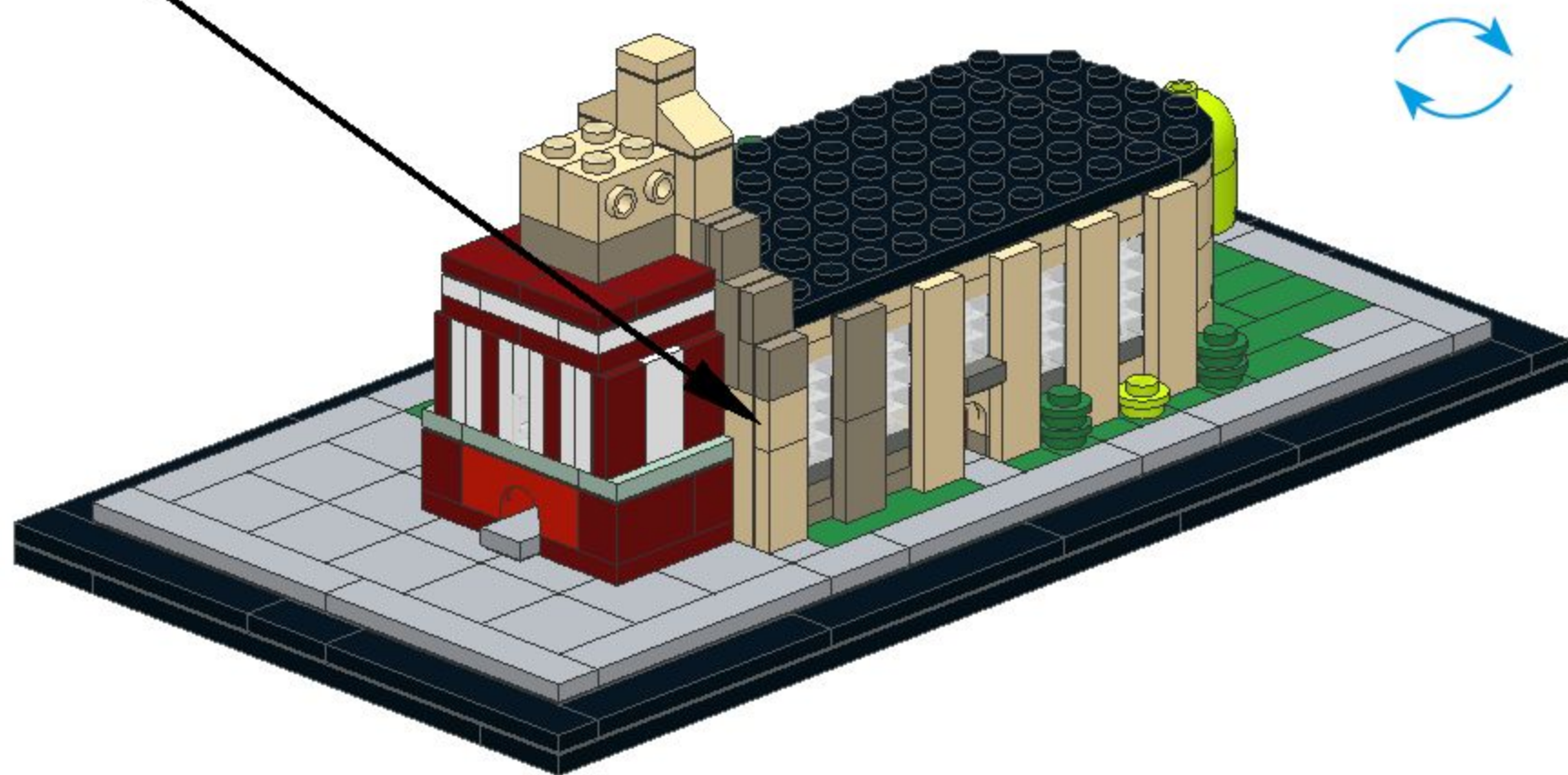

# 28

	
<b>1x</b>	<b>2x</b>
	
<b>1x</b>	<b>1x</b>
	
<b>1x</b>	<b>1x</b>
	
	
	<b>3x</b>

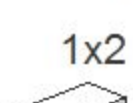
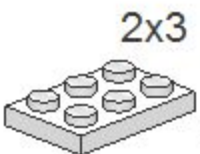

# 29

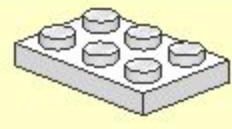
		
<b>1x</b>	<b>2x</b>	
		
<b>1x</b>	<b>1x</b>	
		
<b>1x</b>	<b>3x</b>	<b>1x</b>

- 1 
- 2 
- 3 

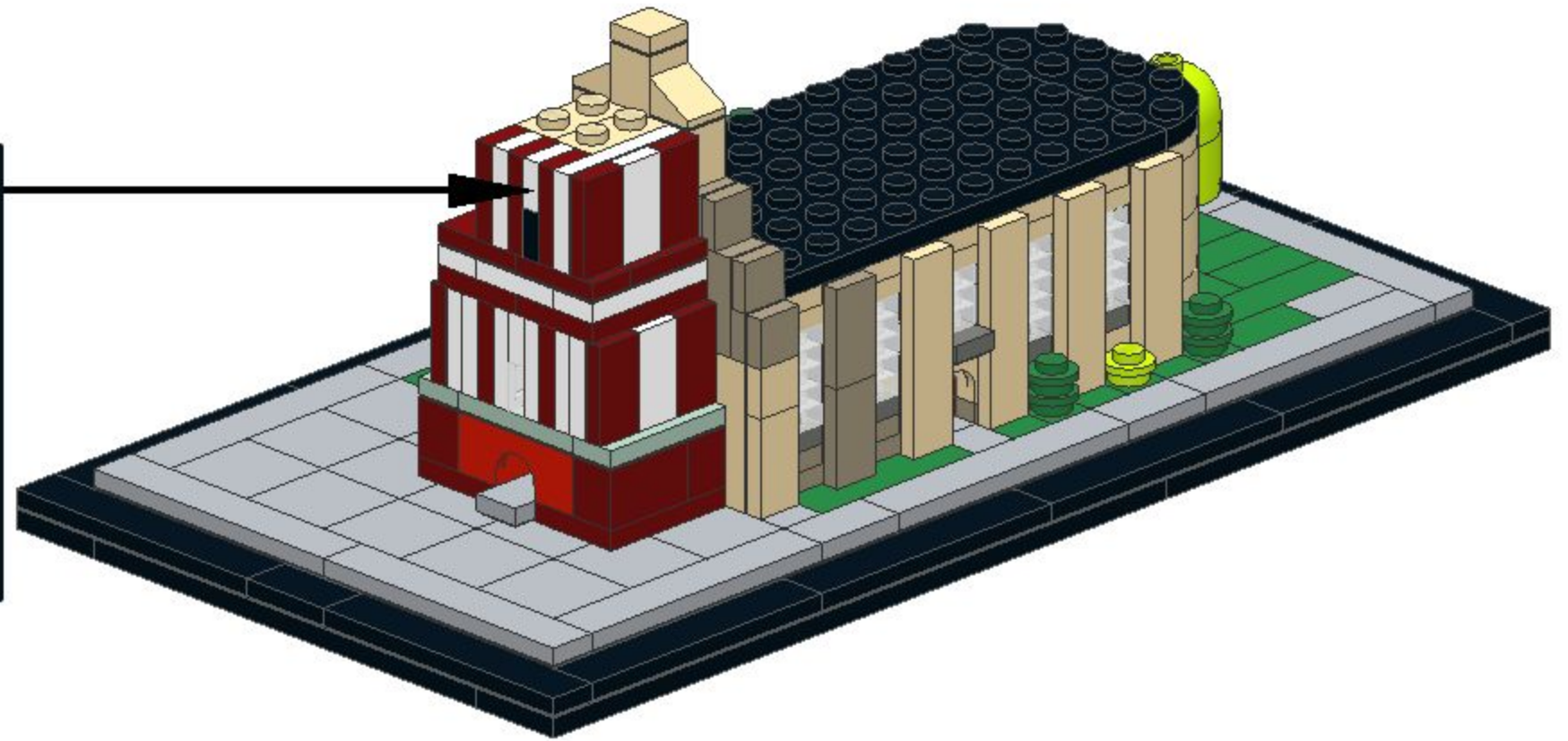

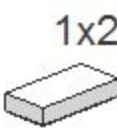
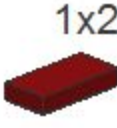
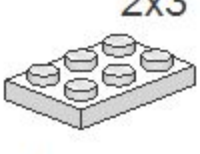

# 30



<b>1x</b>

<b>2x</b>

<b>1x</b>

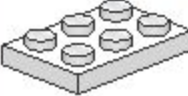

# 31

1x2  
  
**1x**

1x1  
  
**2x**

2x3    1x1  
   
**2x**    **1x**







# 32

1x2  
  
**1x**

1x2  
  
**5x**











33

1x2	1x2
	
<b>1x</b>	<b>1x</b>
1x1	1x1
	
<b>1x</b>	<b>1x</b>









# 34

- 1x2 
- 2x 
- 1x2 
- 1x 
- 2x2 
- 1x 

- 
- 
- 



# 35

- 1x2 
- 2x 
- 1x2 
- 1x 
- 2x2 
- 1x 





# 36

1x2

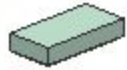

**2x**

1x2



**1x**

1x3



**2x**



# 37

1x1



**1x**

1x2

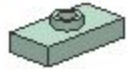

**1x**

1x2

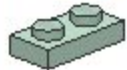

**2x**



# 38



2x

452x2



2x

2x2



3x

452x4

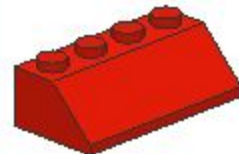

5x



# 39

452x1



2x

452x2



2x

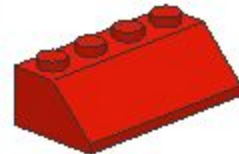

452x4



4x

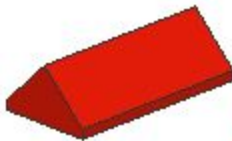

40

452x4	451x2	452x1
		
<b>2x</b>	<b>1x</b>	<b>1x</b>



